

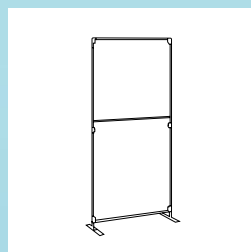

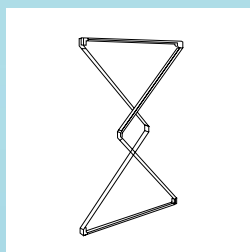

# FASTFRAME™

TRANSFORM SPACES IN SECONDS

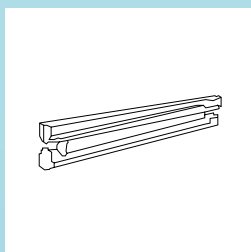

Introducing your **innovative**  
and **cost-effective** modular  
Display Solution.





**FASTFRAME™** is a unique, **sustainable** and **user-friendly** Display Solution, only from Ultima Displays.



### **More versatile than a pop-up**

- » Highly configurable
- » Seamless graphics
- » Easy to change Silicone Edge Graphics (SEG)
- » Many applications



### **More flexible than a roller banner**

- » Assembled in seconds
- » Lightweight, highly portable
- » One frame, multiple graphics
- » Single or double sided graphics
- » Expandable, no joints
- » Washable stretch fabric
- » Cost savings through repeated use



### **More configurable than an exhibition stand**

- » Expandable – add modules over time
- » Quick change design
- » Excellent space utilisation
- » Toolless construction
- » Seamless graphic overlay

# Transform your space in seconds using **FASTFRAME™**



## 1. Folded state

The lightweight frame is pre-assembled in a convenient, portable carry bag.



## 2. Unfold

From its pre-assembled state, the frame can then be effortlessly unfolded and locked in place with a central support rod.

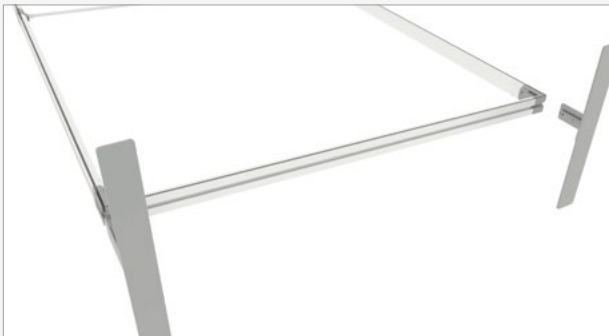

## 3. Components

Feet can be added if required to add additional rigidity to the frame.



## 4. Install graphics

Your graphics, available in a Standard or Premium finish, can then be applied to the fully assembled frame.

## **Sustainable** exhibitions

**With sustainability a key theme for event organisers and exhibitors alike, modular exhibition systems offer an environmentally conscious choice.**

- » Made from aluminium, an infinitely recyclable material
- » Using polyester graphic materials which can be recycled multiple times
- » Graphics printed using water based inks
- » One system for multiple display applications



Enjoy **many benefits**, such as:



### **An efficient toolless frame**

Unit can be constructed and ready in a short amount of time.



### **Lightweight and ultra slim**

Unit is highly portable, making travel and storage much easier.



### **Seamless graphic**

Apply a single graphic to connected frames to create a large seamless display.



### **Sustainable**

Multiple use, not single use.



### **Interchangeable graphics**

Display multiple messages time and time again.





## FASTFRAME™ utilises **Silicone Edge Graphics**

- » Fabric graphics are edged with a silicone strip which slots into the channel of the frame for easy installation
- » This is more cost-effective than alternative options and can be used multiple times
- » The graphics are printed using water based inks which is more eco-friendly
- » Seamless graphics can be applied to the connected frames for large displays
- » Graphics can be reproduced to deliver new messages



## Assemble **countless configurations**

One system, endless applications for all spaces.

- » Product launches
- » Pop-up display
- » Mid-size exhibition
- » Conferences
- » Recruitment fair
- » Reception display

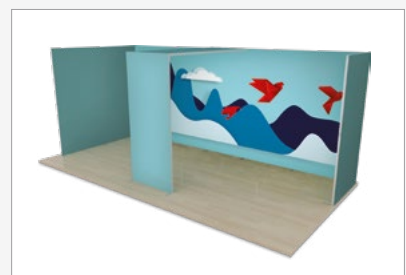
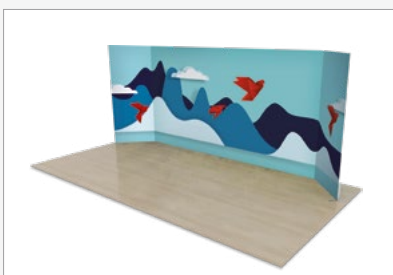
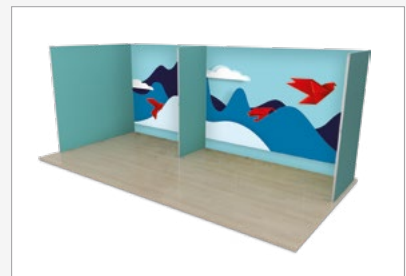

## Use **different connectors**

Enabling you to create an infinite amount of configurations.

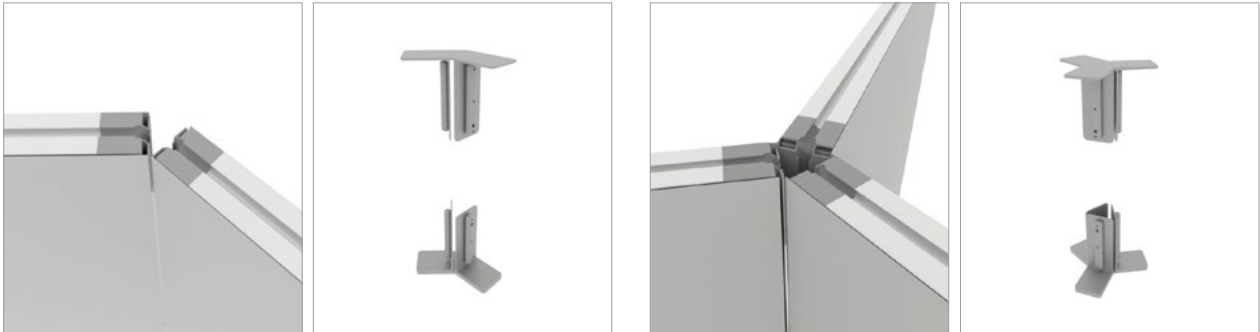

## A **range of sizes** available

**FASTFRAME™** is available in 5 sizes, all with a slimline 40mm frame profile.

- » 1000 x 500mm
- » 1000 x 1000mm
- » 1000 x 2000mm
- » 1000 x 2400mm
- » 1200 x 2400mm

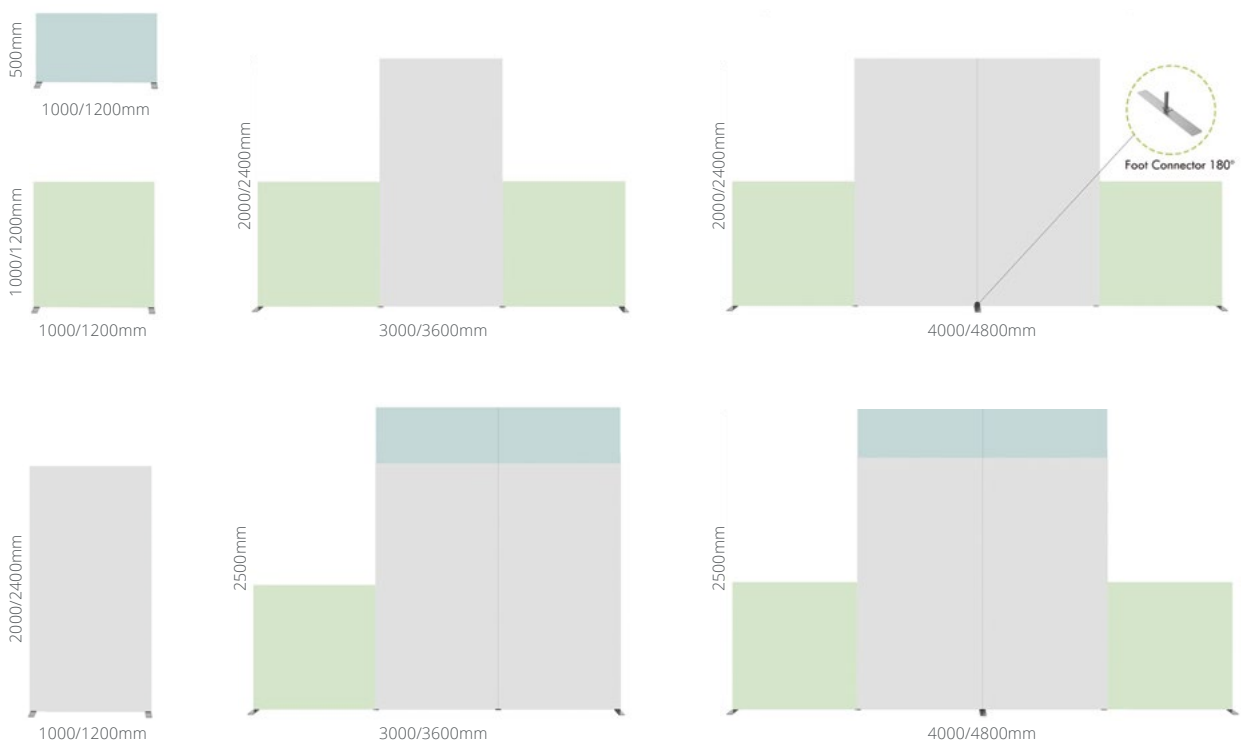

ULTIMA DISPLAYS FRANCE SAS  
15 rue de la Mainguais  
44470 Carquefou  
FRANCE

+33 (0) 2 40 20 14 20  
info.fr@ultimadisplays.com



ULTIMA DISPLAYS ESPAÑA  
Travesía de la Barca, Nave B-3  
19208 Alovera, Guadalajara  
ESPAÑA

+34 949 04 70 08  
info.es@ultimadisplays.com

ULTIMA DISPLAYS POLSKA SP. Z O.O.  
Będzieszyn 103  
83-000 Będzieszyn  
POLSKA

+48 58 770 22 80-84  
info.pl@ultimadisplays.com

ULTIMA DISPLAYS PORTUGAL  
Av. Pedro Álvares Cabral, 169  
Centro Empresarial Sintra Estoril IV - Arm. F  
Linhó  
2710-144 Sintra  
PORTUGAL

+351 215 955 568  
info.pt@ultimadisplays.com

ULTIMA DISPLAYS LIMITED  
49-50 Causeway Road  
EarlStrees Industrial Estate  
Corby, Northants  
NN17 4DU  
UNITED KINGDOM

+44 (0)1536 272250  
info.uk@ultimadisplays.com

