

## Montage der Struktur

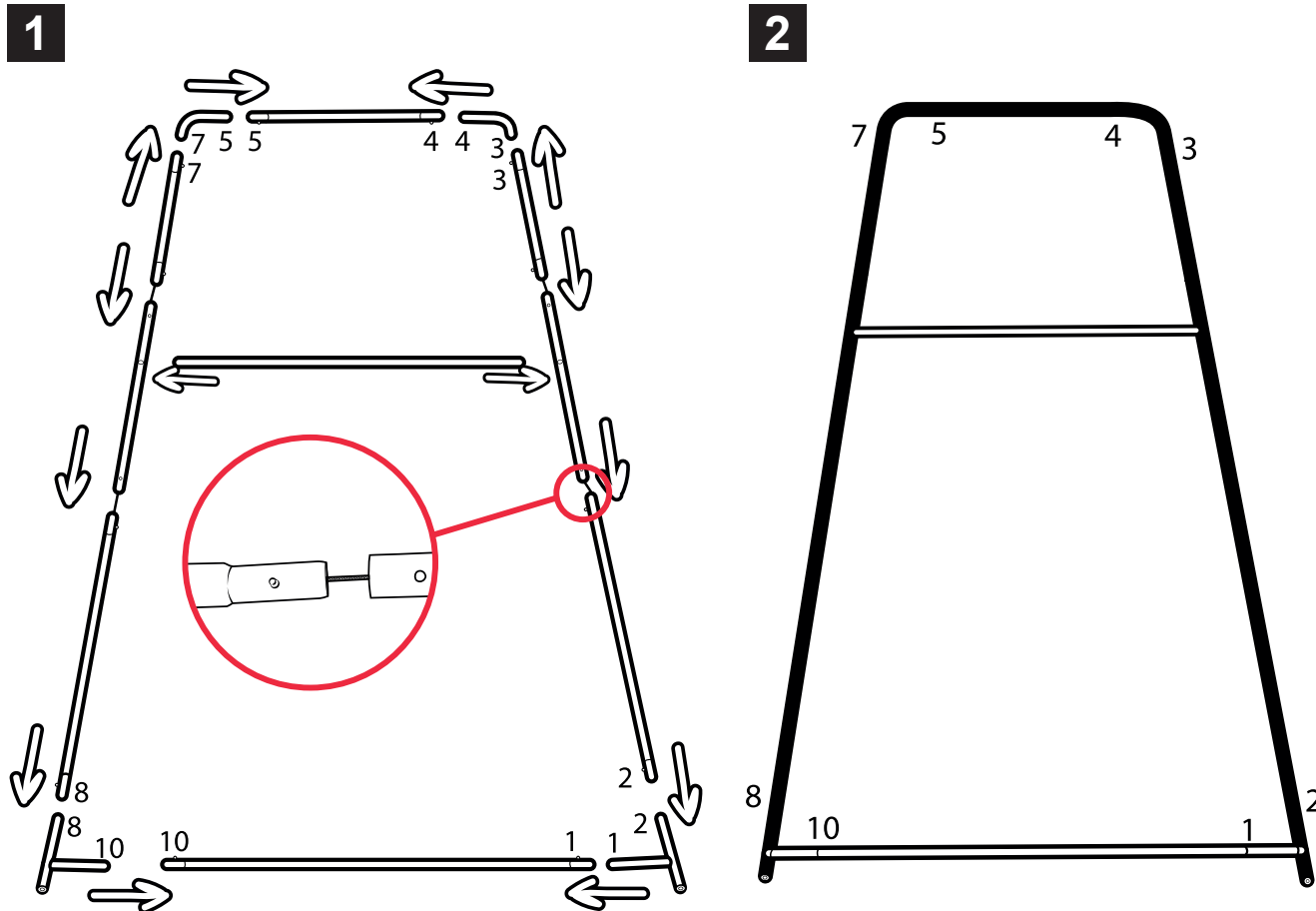

## Anbringen der Grafik

1

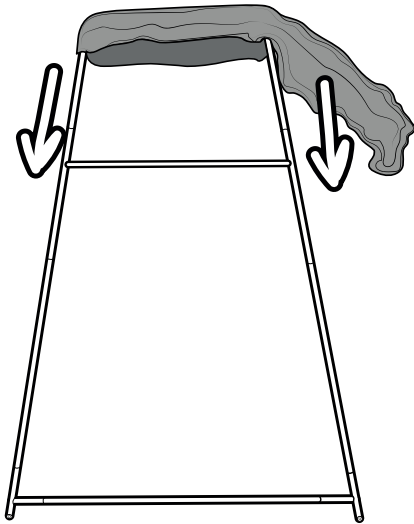

2

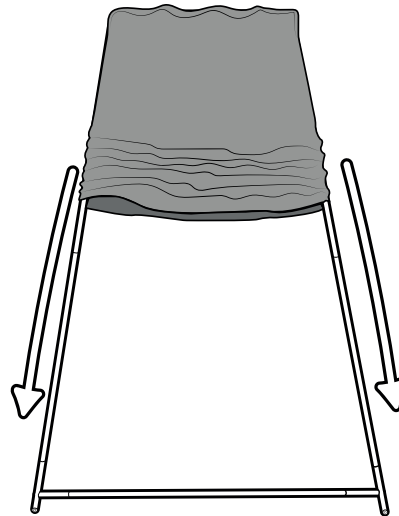

3

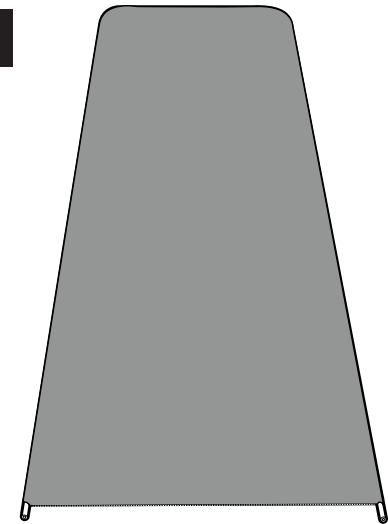

## Anbringen der FüÙe

1

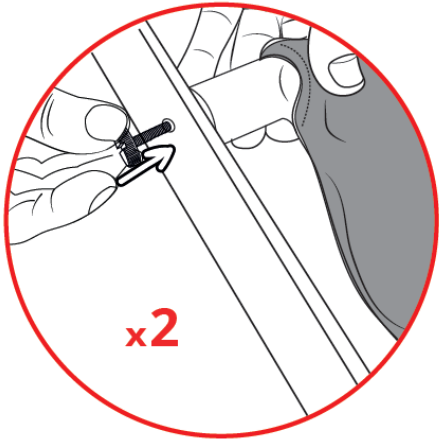

2

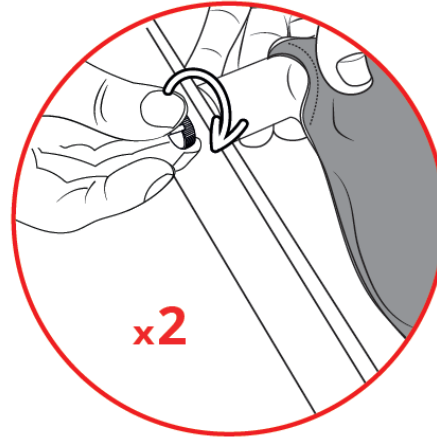

4

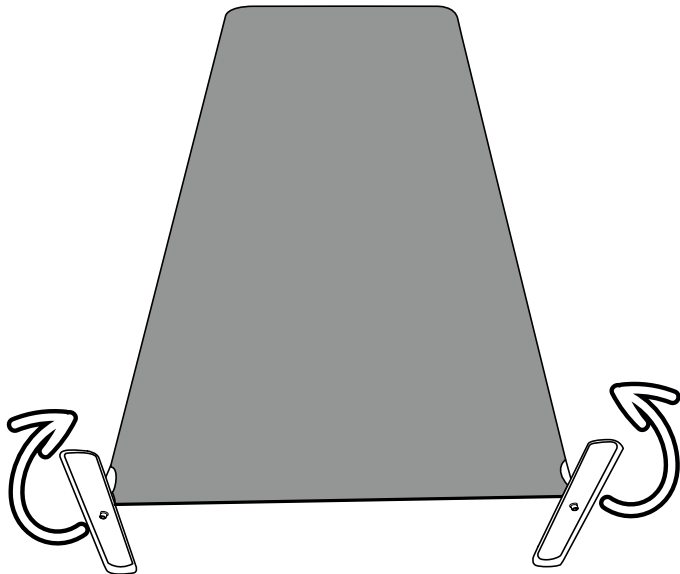

5

